

DATE	September 2025	CODE	KLLED-M-I-K3	A
------	----------------	------	---------------------	----------

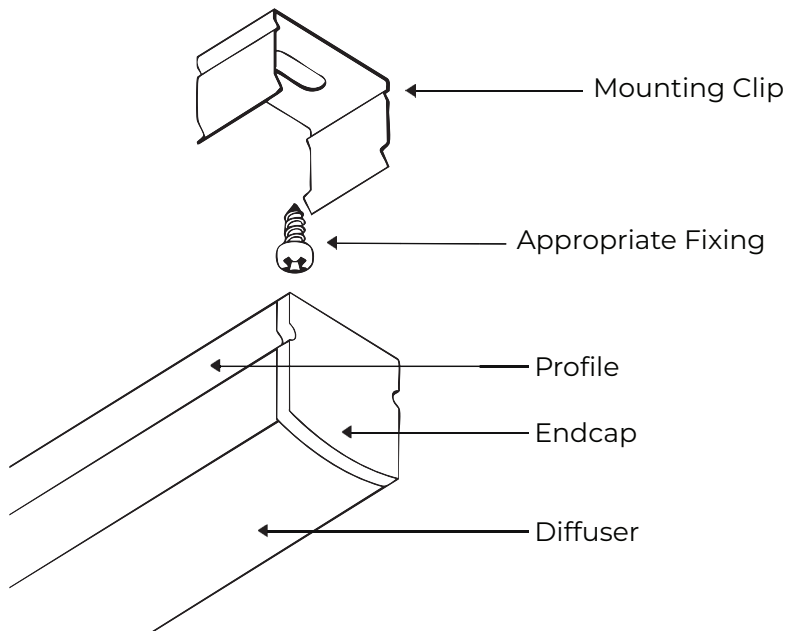

SUPPLIED PARTS

- Diffuser
- Classic 15 Profile
- Mounting Clips
- LED Strip with soldered tail
- 2x endcaps per run

REQUIRED FOR INSTALLATION

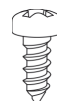

Appropriate Fixing - see notes below
(1 per Bracket)

CRITICAL DIMENSIONS

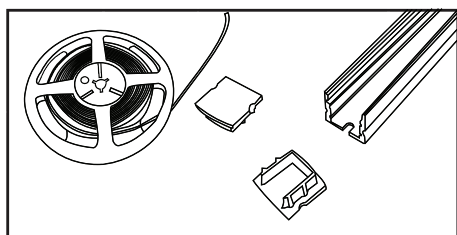
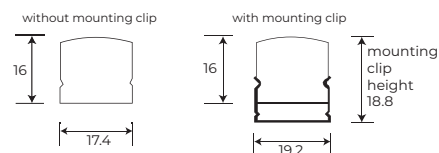

1. Identify all parts required for each kit form run being assembled.

Kit Form orders will be supplied to lengths as requested. Ensure lengths onsite have not changed. Once LED Strip has been placed in the channel, it cannot be removed.

Intralux will always supply a routed out profile to accommodate wire exit in starter fitting. Ensure this fitting is placed in the correct location for the run.

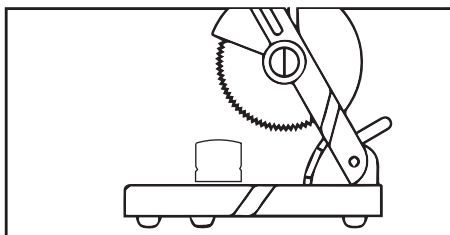

2. If length alterations need to be made, please do the following:

Tips for a good finish:
We recommend using a mitre saw fitted with a fine-tooth multi material blade.

We recommend installing the diffuser to the profile and cutting both at once. The diffuser should always face the saw blade, and care should be taken to cut slowly at the beginning and end of the cut as to reduce the likelihood of the blade catching the diffuser and breaking it.

To shorten LED Strip:
Always shorten from the end without the pre-soldered tail. Only cut LED Strip on 50mm increment.

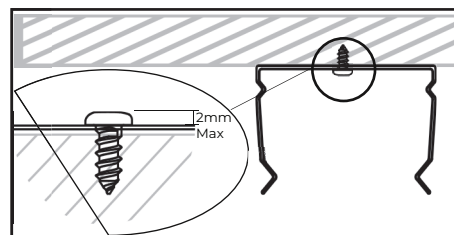
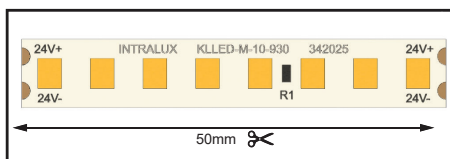

3. Mark and pre-drill screw holes prior to inserting mounting screws through Mounting Clips.

Mounting Clip suggestions

- 0-1000mm = 2 mounting clips
- 1050- 1550mm = 3 mounting clips
- 1550- 2050mm = 4 mounting clips
- 2050- 2550mm = 5 mounting clips

NOTE:

Mounting fastener head should NOT be taller than ~2mm.

Appropriate fastener:
Most 4G / #4 screws
Pan head or CSK



ESD Warning!

Always ensure to discharge yourself of all charge by touching a grounded, bare metal surface or approved anti-static mat before handling device. This product contains parts and assemblies susceptible to damage by electrostatic discharge.

DATE	September 2025	CODE	KLLED-M-I-K3	A
------	----------------	------	---------------------	----------

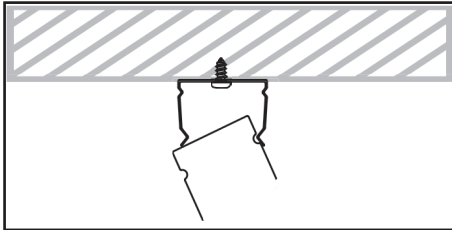

4. The profile must now be attached to the mounting clip in preparation for attaching the LED Strip.

Start with the 'Starter' Profile first and work your way along the length of the run.

Tilt the profile and push into rear of bracket to engage.

Mounting clip will flex to fit.

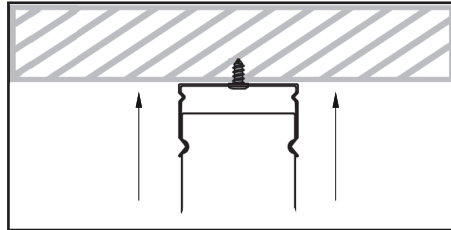

5. Pivot the front down and push firmly to engage the front of the bracket and snap-fit.

Once all of the profile for the run length are attached to the mounting clips, installation of the LED Strip can begin.

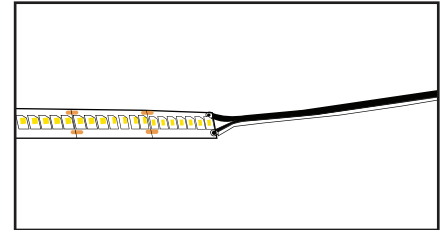

6. The LED Strip will be provided on a spool which reduces the touching of the LED Strip.

We recommend the use of clean powder free gloves when applying the strip to the profile.

Do not press down hard onto the LED Strip.

Do not run your fingers along the LED Strip.

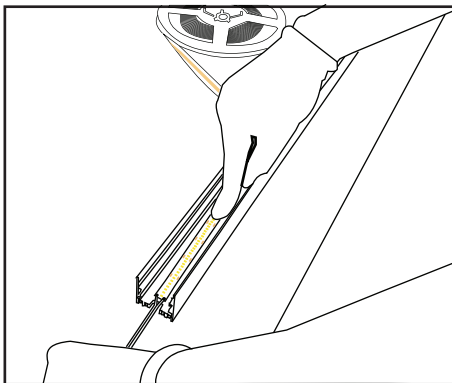

7. Place the LED Strip into the center spline of the profile, aligning the pre-soldered tail with the routed out wire exit.

While peeling back the double sided tape backing, gently press down the strip along the length of the profile. Continue this motion along the entire run length until the entire length of LED Strip has been attached.

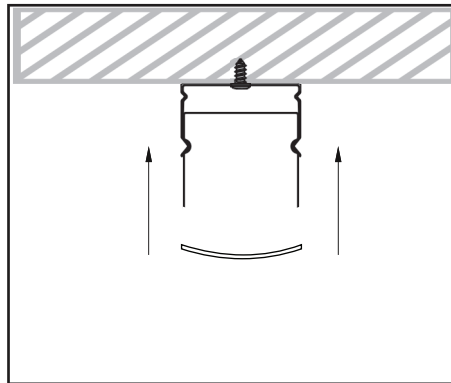

8. Push diffuser into the profile at one end then gently press along the rest of the length to secure into profile.

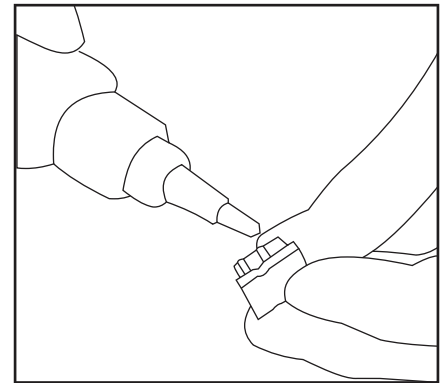

9. Using the Loctite 460 Instant adhesive or similar, dab some glue in each corner making contact with the profile.

For continuous runs when assembly is required use a low odour + Low Bloom instant such as **'LOCTITE 460 INSTANT ADHESIVE'** or a similar adhesive for attaching endcaps to the end of the profile.

DATE	September 2025	CODE	KLLED-M-I-K3	A
------	----------------	------	---------------------	----------

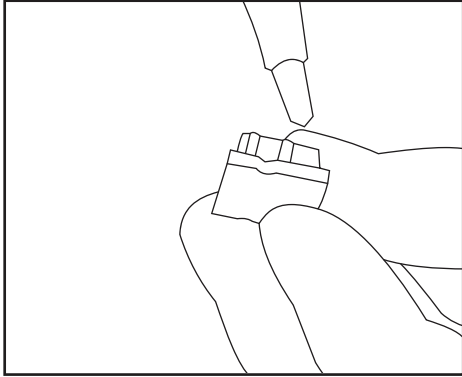

10. Once each point has been glued, push the endcap onto the end of the profile.

Hold in place until glue has set otherwise end cap will fall off.

(Recommended hold time 30-60 secs)

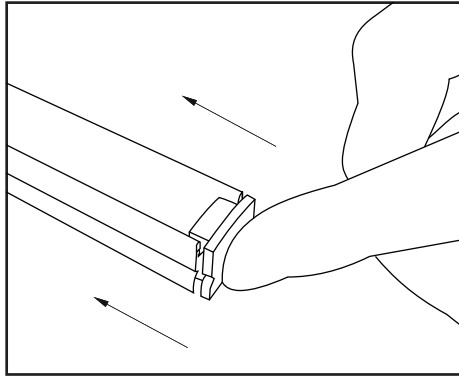

11. Once endcap is pushed on the end of the profile, wipe any excess glue that may seep out.

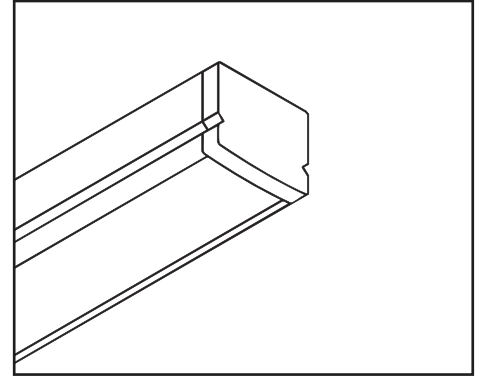

12. Your Kit Form installation is now complete.

DATE	October 2025	CODE	KLLED-M-I-K10	A
------	--------------	------	----------------------	----------

FIXED OUTPUT - TYPICAL WIRING CONFIGURATION

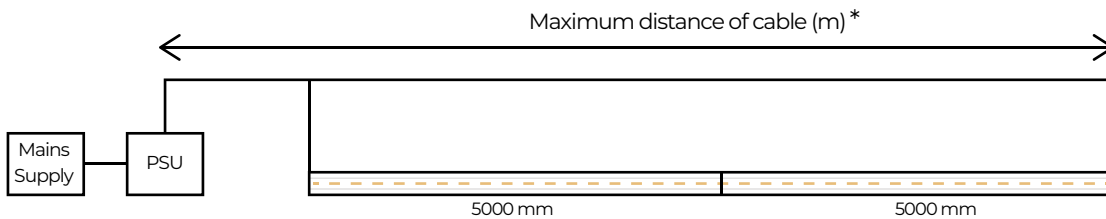

1-10V - TYPICAL WIRING CONFIGURATION

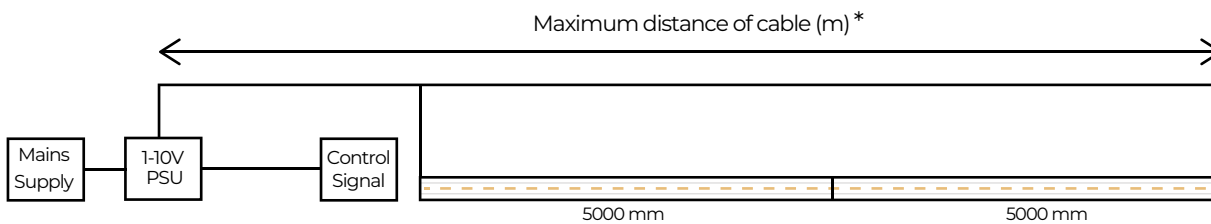

DALI / DMX / SWITCHDIM - TYPICAL WIRING CONFIGURATION USING SINGLE CHANNEL DRIVER

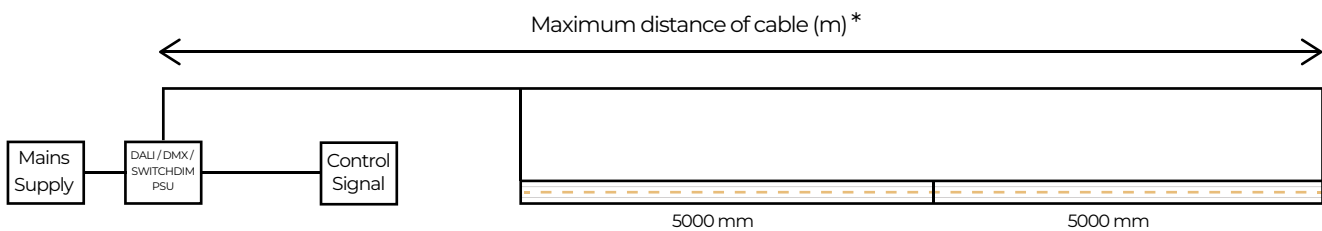

Cable Size (Gauge)	Wattage (Load per cable)				
	18W	35W	60W	100W	200W
0.5mm ²	24m	12m	7m	4m	2m
1.0mm ²	41m	21m	12m	7m	3m
1.5mm ²	60m	31m	18m	10m	5m
2.5mm ²	100m	51m	30m	18m	9m

Note, this table should allow for a voltage drop of no more than 5% - however, other factors may influence the exact result - so this should be used as a guide only.

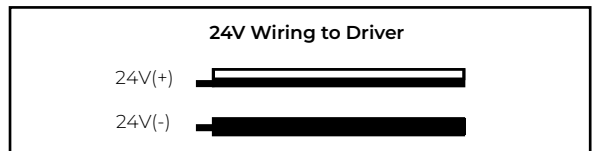

Tip - when using higher wattage drivers, it is often more practical to split the load from the LED driver into two or more cables allowing for smaller cable gauge size and/or longer distances between drivers and LED strip.



CAUTION:

To avoid voltage drop, ensure no more than 5000mm of Kove LED Mini connected together off one pre-solded tail. For longer runs, you can connect multiple starter leads to appropriate sized cable per the cable size/wattage chart.

DATE	October 2025	CODE	KLLED-M-I-K11	A
------	--------------	------	----------------------	----------

DALI DT6 / DALI DT8 - RGBW AND TUNABLE WHITE - TYPICAL WIRING CONFIGURATION USING DALI DRIVER

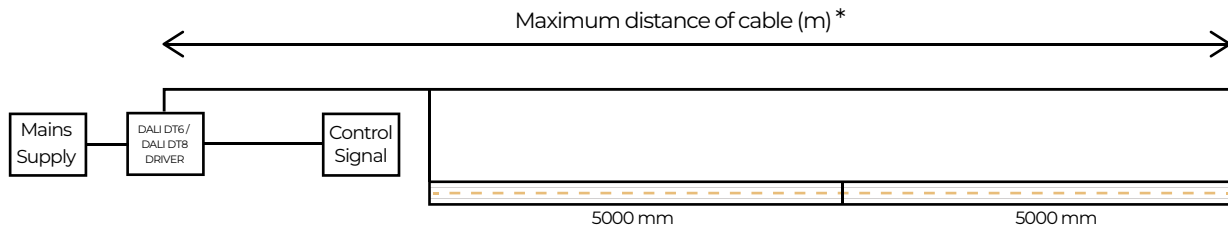

DMX - RGBW AND TUNABLE WHITE - TYPICAL WIRING CONFIGURATION USING DRIVER AND DMX CONTROLLER

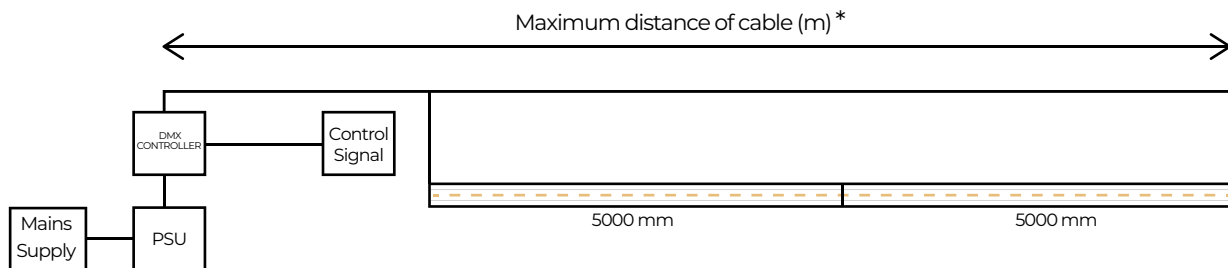

Cable Size (Gauge)	Wattage (Load per cable)				
	18W	35W	60W	100W	200W
0.5mm ²	24m	12m	7m	4m	2m
1.0mm ²	41m	21m	12m	7m	3m
1.5mm ²	60m	31m	18m	10m	5m
2.5mm ²	100m	51m	30m	18m	9m

<p>Note, this table should allow for a voltage drop of no more than 5% - however, other factors may influence the exact result - so this should be used as a guide only.</p>	<p>RGBW Wiring Guide:</p> <p>24V (+) = Black Red (-) = Red Green (-) = Green Blue (-) = Blue White (-) = White</p>	<p>Tunable White Wiring Guide:</p> <p>24V (+) = Red Warm White (-) = Black Cool White (-) = Yellow</p>
--	---	---

<p>Tip - when using higher wattage drivers, it is often more practical to split the load from the LED driver into two or more cables allowing for smaller cable gauge size and/or longer distances between drivers and LED strip.</p>



CAUTION:

To avoid voltage drop, ensure no more than 5000mm of Kove LED Mini connected together off one pre-soldered tail. For longer runs, you can connect multiple starter leads to appropriate sized cable per the cable size/wattage chart.