

DATE	June 2019	CODE	KLED-M-I-8	A
PROJECT		TYPE		

## Supplied parts

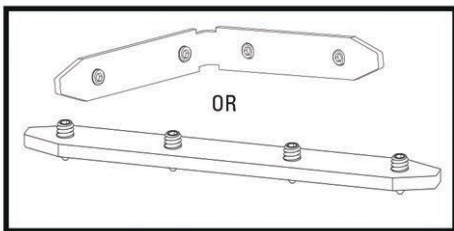

1. Pre apply grub Screws to Connector Brackets.

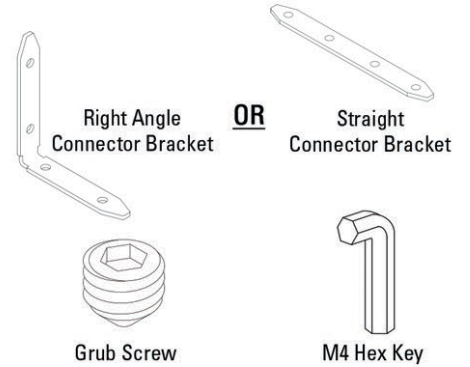
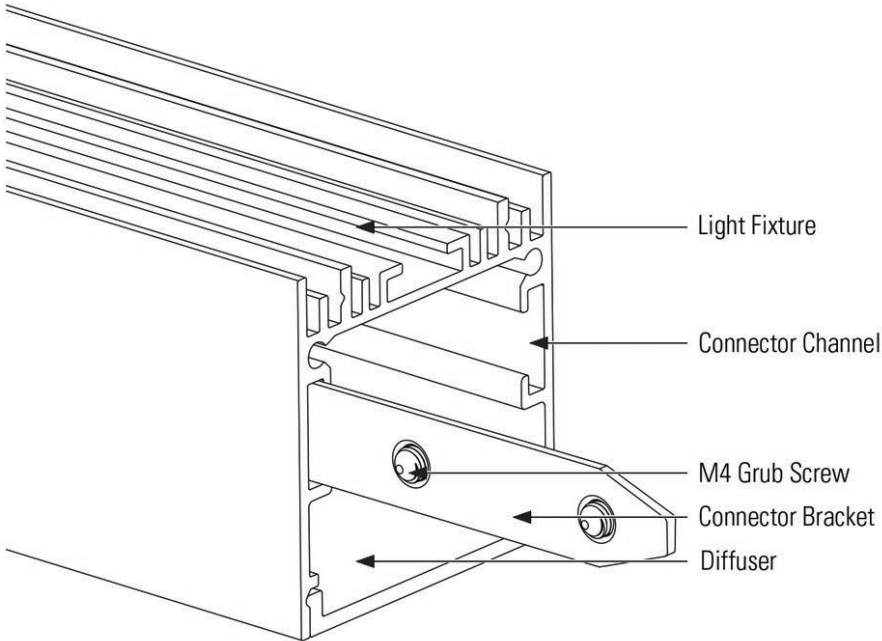
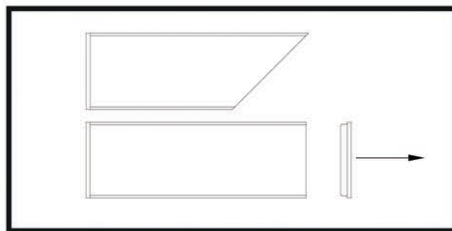

2. Remove the Endcap by pulling it if required.

**NOTE:**  
Only remove the Endcaps on the sides that are going to be connected.

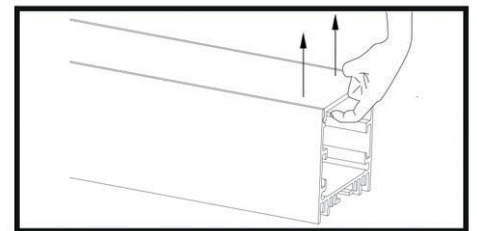

3. Remove diffuser by pulling it up and out of its track.

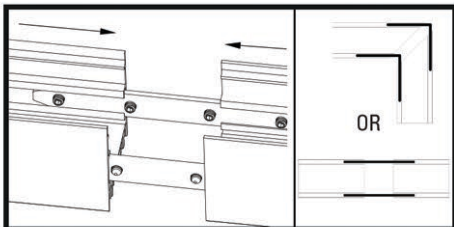

4. Slide Connector Brackets into the Connector Channels.

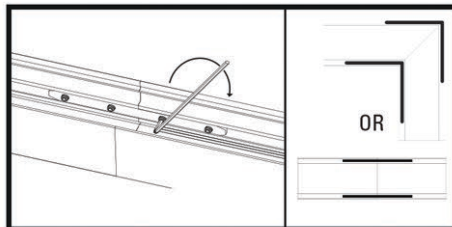

5. Align Fixtures until they seamlessly fit together. Tighten Grub Screws to Lock Fixtures into place.

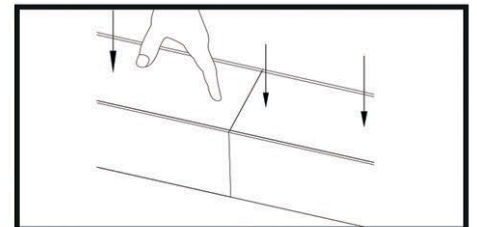

6. Replace Diffuser by pushing it back into its track. Repeat for further connections.