

DATE	April 2023	CODE	COMPACT-IS-2	A
PROJECT		TYPE		

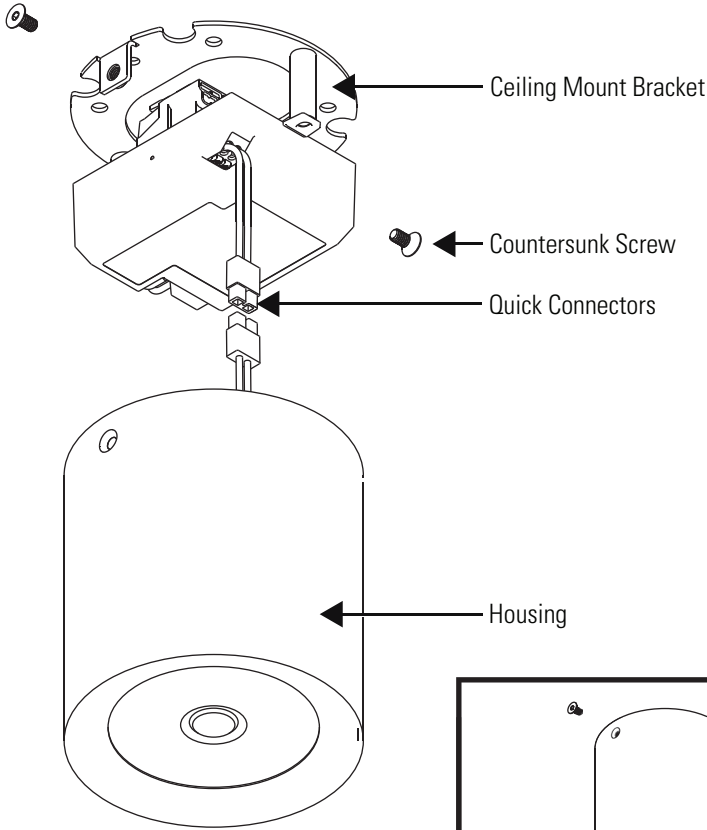

Supplied parts

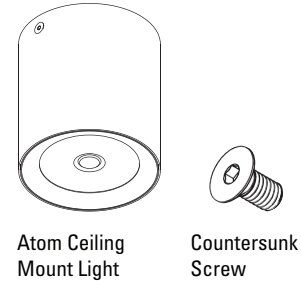

Required for Installation

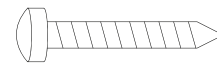

Appropriate Fixings

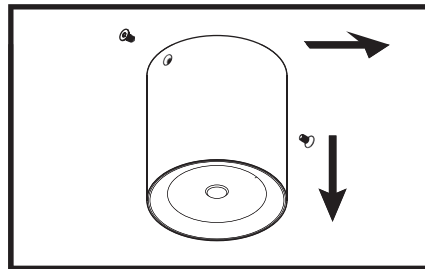

1. Remove the two M4 countersunk screws.

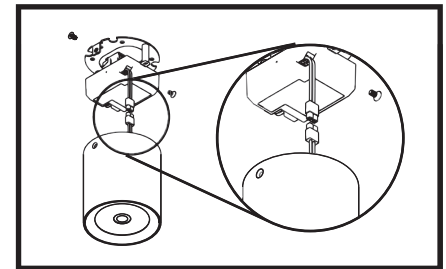

2. Slide the luminaire off the mounting bracket, disconnecting the quick connectors. Set the luminaire aside.

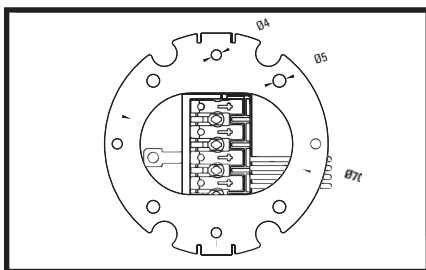

3. Attach the ceiling mount bracket using appropriate fixings. There are 4mm and 5mm hole options, all centred on 70mm diameter.

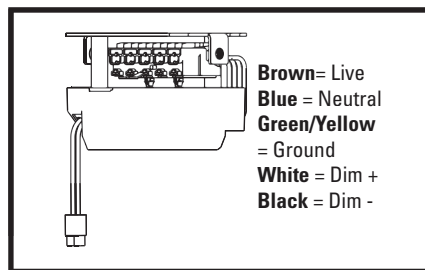

4. Connect the terminal block wiring to building wiring.

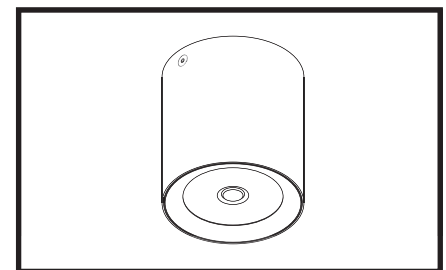

5. Slide the luminaire back over the bracket, reattaching the quick connectors, and fastening the two M4 countersunk screws. Test the luminaire.

Installation is complete.