

DATE	April 2023	CODE	FLED-IS-1	B
------	------------	------	-----------	---

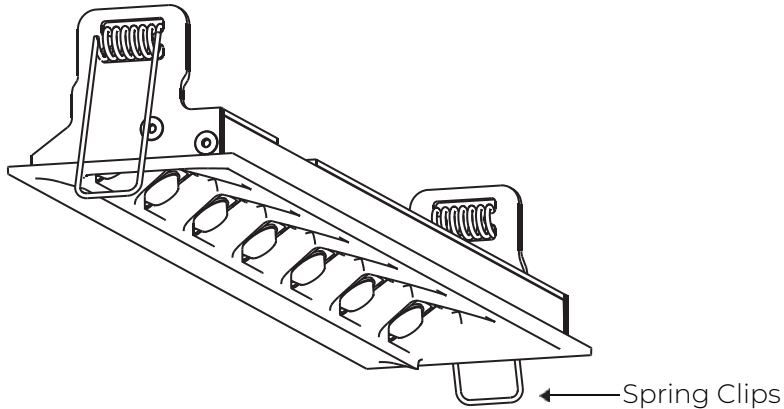

SUPPLIED PARTS

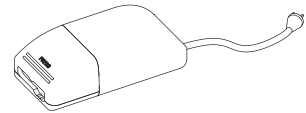

Driver

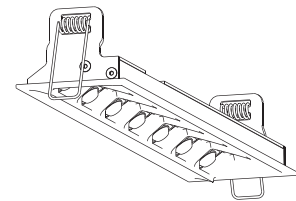

Luminaire

REQUIRED FOR INSTALLATION



Saw or similar

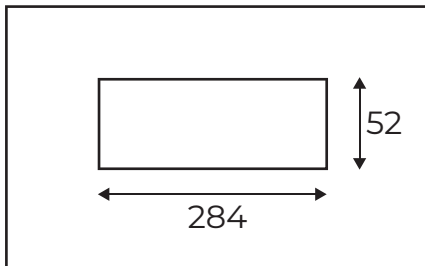

1. Mark and cut a 52mm x 284mm hole in the ceiling.

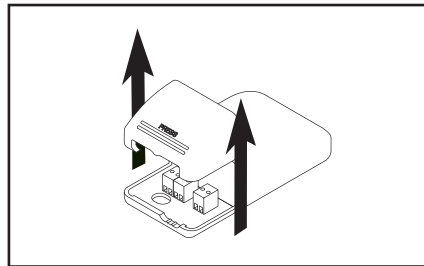

2. If dimming is required, open the strain relief.

If no dimming is required, skip to step 6.

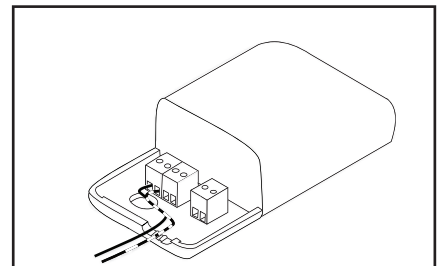

3. Connect building dimming wires to the driver.

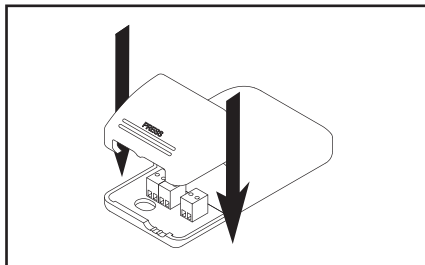

4. Close the driver strain relief.

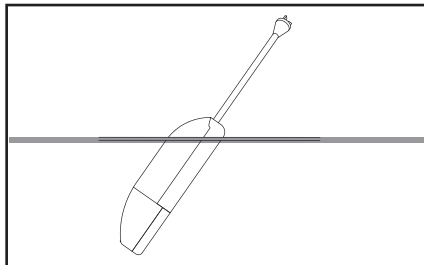

5. Connect orange plug to Luminaire

Your Flare LED is now ready to be installed into the ceiling.

Feed the driver through the ceiling cutout.

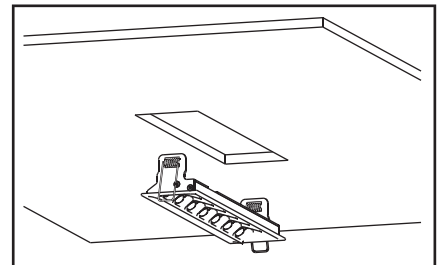

6. Compress the Spring Clips and feed your Flare LED through the cut out in the ceiling.

Your Flare LED is now installed.