

DATE	April 2022	CODE	KLLED-T1	A
PROJECT		TYPE		

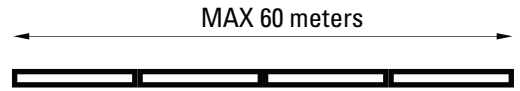

NOTE:
Dependent on module configuration. (IE. driver QTY and TYPE).

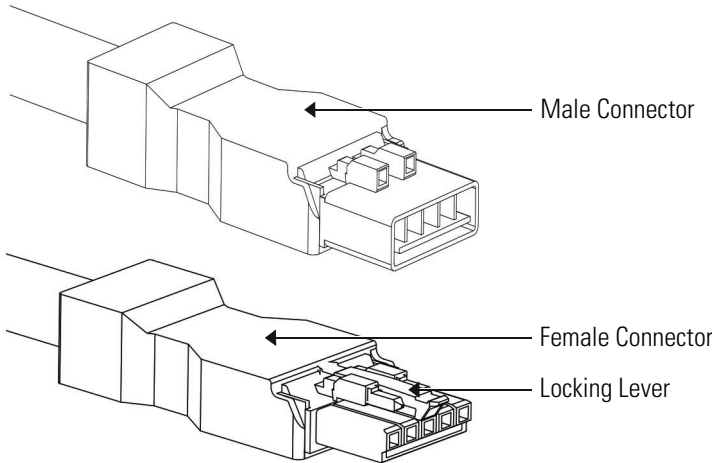

Caution:
Split circuits to be utilized on long runs. Maximum interconnected run length should not exceed 60 meters.

KLLED-T-119 = 0.08A
KLLED-T-1.519 = 0.1A
KLLED-T-219 = 0.16A
KLLED-T-2.519 = 0.19A
KLLED-T-319 = 0.24A
KLLED-T-3.519 = 0.27A
KLLED-T-419 = 0.31A

Fixture Amps determine the run length possibility.

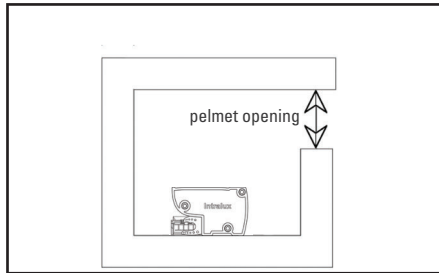

Placement in pelmet.

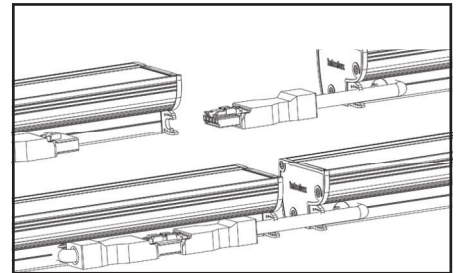

1. Align light fixtures next to each other and connect lights by using the 'PLUG + GO' system.

Make sure the Locking Lever is in the correct position and that the connection is firm.

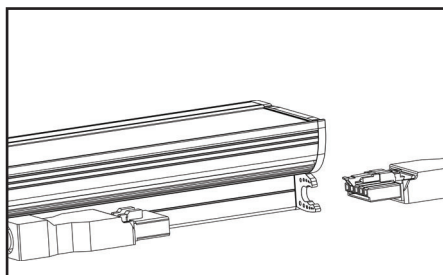

2. Connect the starter lead to the first module of run length.

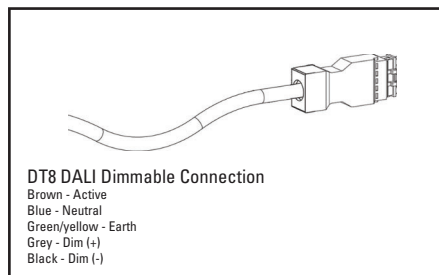

3. Connect the open end of the starter lead to building/control wiring.

DATE	April 2022	CODE	KLLED-T-I-2	B
PROJECT		TYPE		

Supplied parts

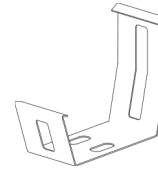

Bracket

Required for Installation



Appropriate Fixing
(2 per Bracket)



Philips Head
Screwdriver

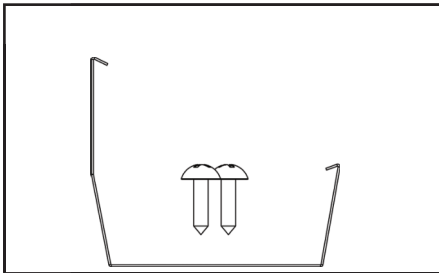
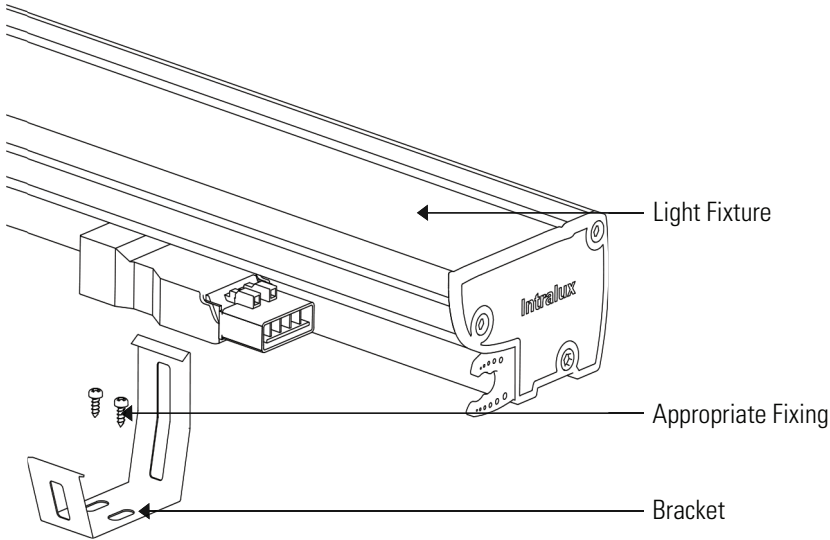

1. Install screws through the two holes in the mounting bracket to secure to surface. Screw head height is to be 4mm.

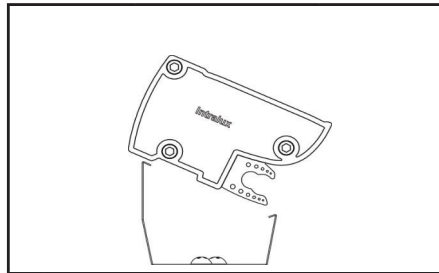

2. Tilt the fixture backward and push until the rear of the bracket engages.

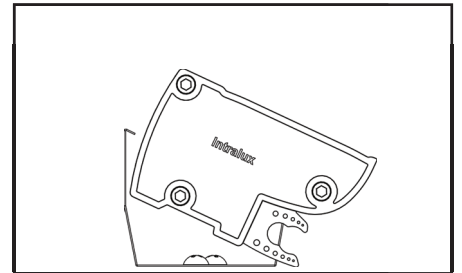

3. Pivot the front down and push firmly to engage the front of the bracket.

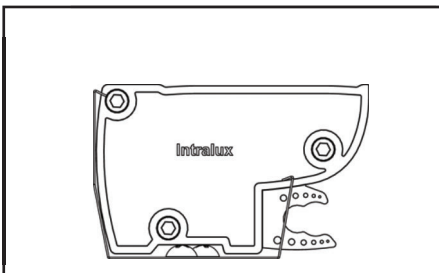

4. Press up and inward on the front leg of the mounting bracket ensuring that the end seats firmly in the corresponding channel.